

## **WR-3 Plus**

### Wireless Anemometer

### User Guide

# Page Contents

---

<b>Introduction</b>	<b>2</b>
<b>Sensor &amp; Receiver</b>	<b>3</b>
<b>Sensor</b>	<b>3</b>
Wireless Connection	3
Transmission Range	3
<b>Receiver</b>	<b>4</b>
Keypad	5
<b>Navigation Diagram</b>	<b>6</b>
MAIN page	7
AVG/MAX page	8
CHART page	8
HISTORY page	9
SETTINGS Page	10
WIND SPEED settings page	10
DATA LOGGING settings page	11
GENERAL settings page	12
<b>Functions</b>	<b>13</b>
Sensors Pairing	13
Wind Speed Alarm	14
Data Logging	14
Data Export	15
Power Saving Mode	17
Power Off	17
<b>Installation</b>	<b>18</b>
Sensor Installation	18
Receiver Installation	18
<b>Technical Specification</b>	<b>19</b>
Wireless Sensor	19
Receiver	19
Wind Speed Sensor	20
Temperature Sensor	20
Atmospheric Pressure Sensor	20
<b>Packing Content</b>	<b>21</b>
<b>Safety, Maintenance, &amp; Warranty</b>	<b>23</b>

# Introduction

---

Scarlet WR-3 Plus is an industrial grade wireless anemometer for multipurpose applications and long-term environmental monitoring.

WR-3 Plus includes a wireless long-range sensor and a portable datalogger display suitable for both permanent and temporary installation.

The system measures current/average/maximum wind speed, temperature, wind chill, Beaufort scale, atmospheric pressure, and historic data graphic in high accuracy with customer selectable measurement units. Users can receive instant data and wind speed alarm at a distance up to 500-meter radius from the sensor.

WR-3 Plus further supports data logging and can export data in excel format to computers by using micro USB output.



# Sensor & Receiver

---

## ■ Sensor

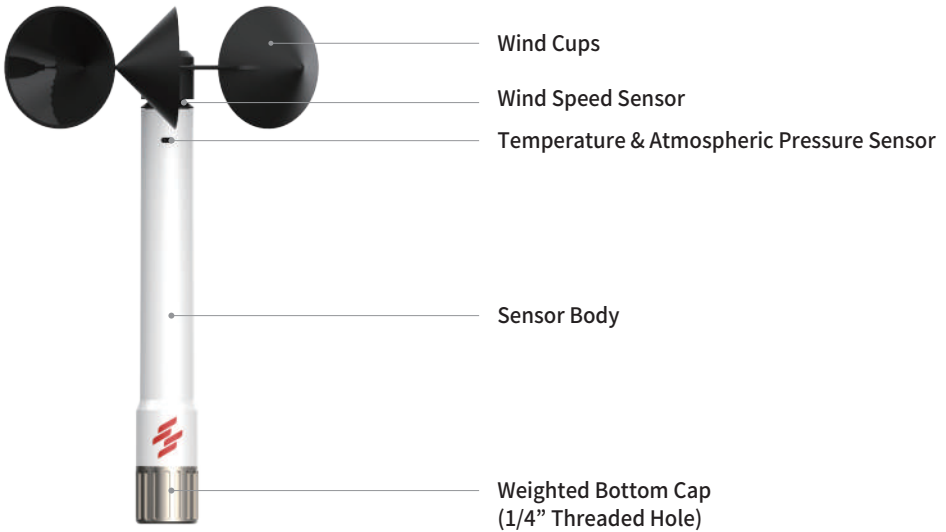

## Wireless Connection

Each sensor has a unique wireless address number that has been pre-paired corresponding to the receiver display. One sensor can be connected to multiple receivers. Several anemometers can operate in close proximity without disturbance.

## Transmission Range

The connection between sensor and receiver goes through Sub-1GHz wireless band (868, 915 MHz). The signal strength is shown on the receiver MAIN page. The transmission range between the sensor and the receiver can reach up to 500 meters in a direct line of sight. Inside buildings or obstacles in between may decrease the transmission range.

Receiver



# Keypad



icon	Name	Functions
	Power	Power ON / OFF
	Settings	Go to Main / Settings page
	Enter	Select; Confirm
	Cancel	Cancel; Go back to the previous page
	Up	Up; Increase number; Change option
	Down	Down; Decrease number; Change option
	Left	Previous page
	Right	Next page

# Navigation Diagram

---

After pressing the Power button, the receiver will enter the MAIN page. Users can press Right/Left and Settings /Cancel buttons to navigate through the pages.

↔ : Switching by **Right** and **Left** buttons

●—● : Switching by **Settings** and **Cancel** buttons

←—→ : Switching by **Enter** and **Cancel** buttons

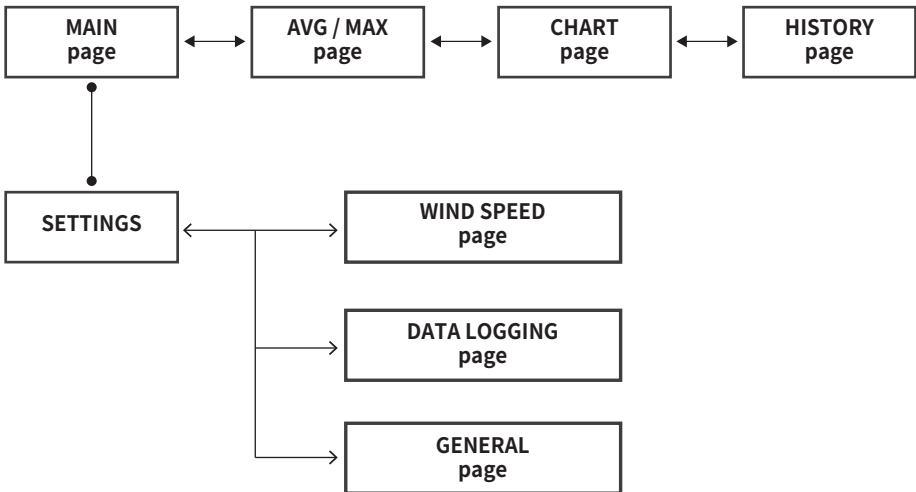

■ MAIN page

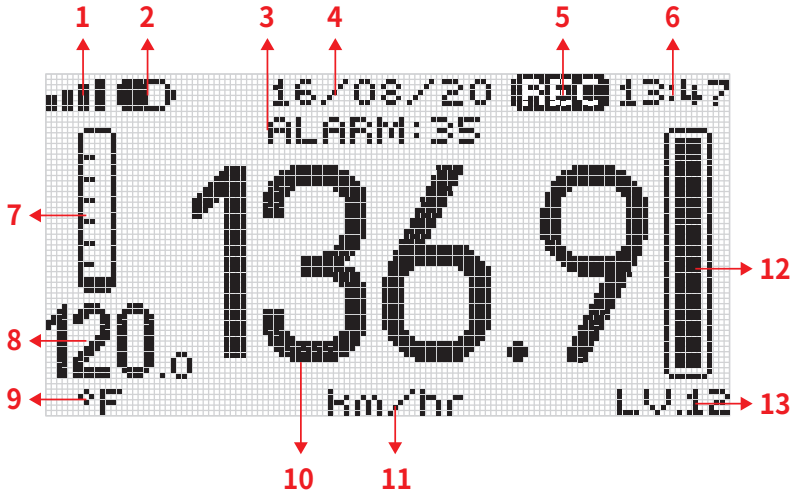

Number	Name	Definition
1	Signal Strength	The wireless signal strength between sensor and receiver
2	Receiver Power	Receiver battery level or power supply through micro USB 
3	Wind Alarm Threshold	The set wind speed alarm trigger threshold
4	Date	Current date in DD/MM/YY
5	Data Logging	Indicate the data logging function is turn ON
6	Time	Current time in HH:MM (24hr military time)
7	Thermometer	Current temperature graph (-10 to 60°C, 7 scales in total, 10°C each scale)
8	Temperature	Current temperature
9	Temperature Unit	Temperature unit: °C or °F
10	Wind Speed	Current wind speed
11	Wind Speed Unit	Set wind speed unit (m/s, km/hr, MPH, knots)
12 & 13	Beaufort Scale	Beaufort wind force scale (unit BFTS, 12 levels in total)



■ AVG/MAX page

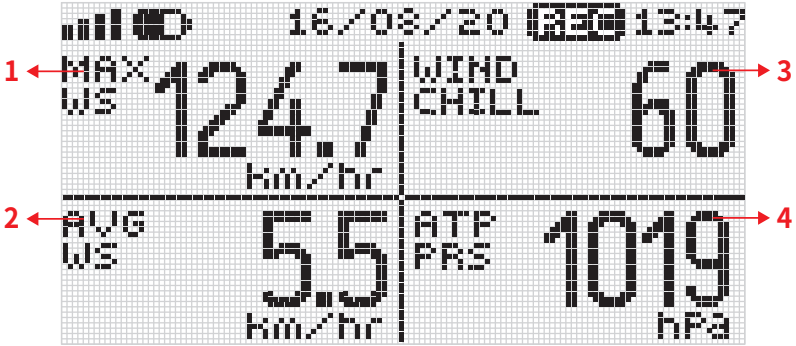

Item	Name	Definition
1	Maximum Wind Speed	Maximum wind speed for the past 12 hours since Receiver turns ON
2	Average Wind Speed	Average wind speed for the past 12 hours since Receiver turns ON
3	Wind Chill	Current wind chill index
4	Atmospheric Pressure	Current atmospheric pressure

■ CHART page

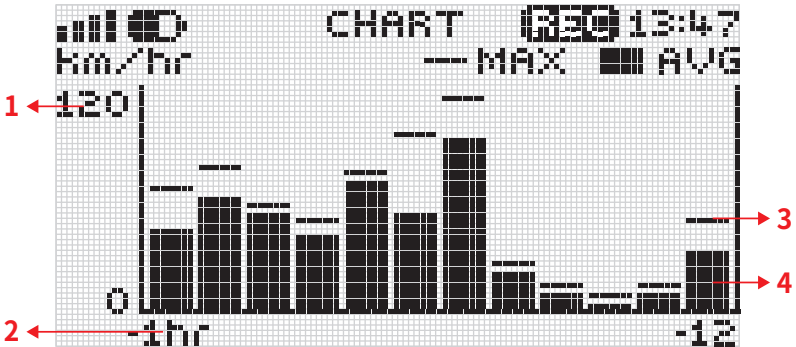

Item	Name	Definition
1	Wind Speed Value	Show wind speed value. (0 to max selectable unit)
2	Time	Show hourly wind speed data from the past 12 hours from the current time (from -1 to -12)
3	Maximum Wind Speed	The period of maximum wind speed
4	Average Wind Speed	The period of average wind speed

■ HISTORY page

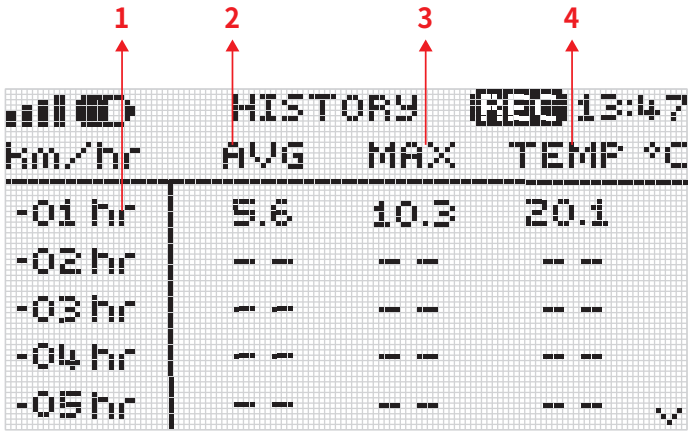

Item	Name	Definition
1	Time Period	The past 12 hours of wind data from the current time (from -1 to -12)
2	Average Wind Speed	Average wind speed of the corresponding period
3	Maximum Wind Speed	Maximum wind speed of the corresponding period
4	Average Temperature	Average temperature of the corresponding period

## ■ SETTINGS Page

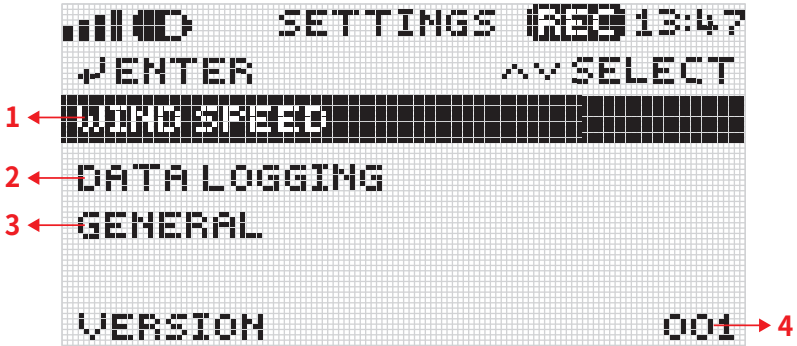

Item	Name	Definition
1	Wind speed page	Wind speed and alarm setting
2	Data logging page	Data logging setting and management
3	General page	General setting page
4	Version	Current receiver firmware version info

## ■ WIND SPEED settings page

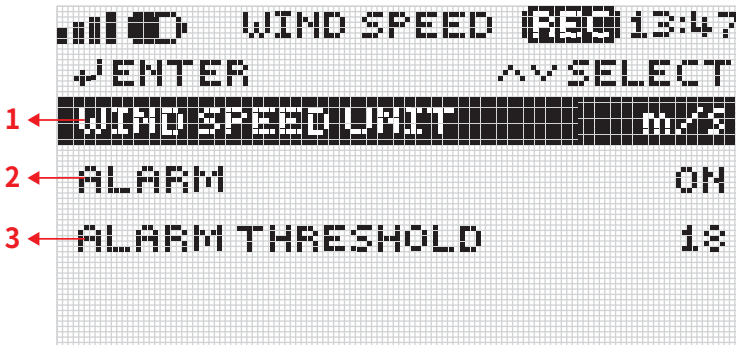

Item	Name	Definition
1	Wind Speed Unit	Wind speed measurement unit: m/s (default), km/hr, MPH, knots
2	Alarm	Wind speed alarm function: ON (default) /OFF
3	Alarm Threshold	Wind speed alarm threshold: 1 to 180 at selected unit, (default: 18)

## DATA LOGGING settings page

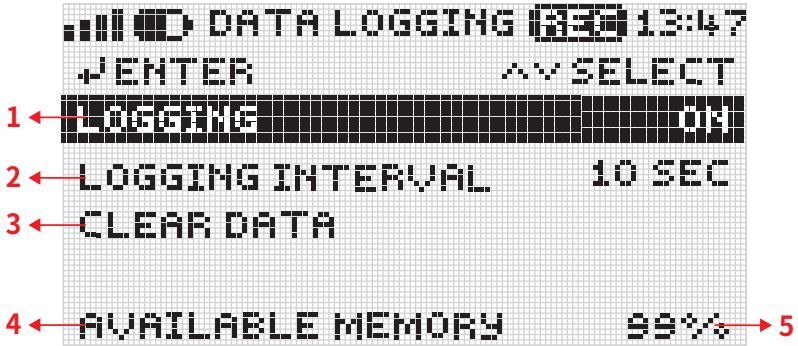

Item	Name	Definition
1	Logging	Logging function: ON / OFF(default)
2	Logging interval	Data logging interval: 2 sec, 5 sec, 10 sec (default), 1 sec, 5 min, 10 min, 60 min
3	Clear data	Clear all data to release the memory
4	Available memory	Remaining data storage space in percentage

## GENERAL settings page

GENERAL 13:47  
 ↵ ENTER ^V SELECT  
 1 ← DATE 18/08/20  
 2 ← TIME 13:47  
 3 ← SENSOR ADDRESS 23  
 4 ← TEMPERATURE UNIT °C  
 5 ← ATMOS PRESS UNIT hPa

GENERAL 13:47  
 ↵ ENTER ^V SELECT  
 6 ← DISPLAY AUTO OFF OFF  
 7 ← SENSOR BATTERY 99%

Item	Name	Definition
1	Date	Set current data. DD/MM/YY
2	Time	Set current time. HH:MM (24hr military time)
3	Sensor Address	Set the wireless sensor address number that connected to this receiver
4	Temperature unit	Unit for temperature measurement. °C (default)/°F
5	Atmospheric pressure unit	Unit for atmospheric pressure measurement. hPa (default), mm Hg, bar
6	Display auto off	Display automatically switch to power saving mode after the set idle period. OFF (default), 5 min, 10 min, 30 min
7	Sensor Battery	Battery power percentage of the wireless sensor

# Functions

## Sensors Pairing

The wireless address number is labelled on the sensor body, as well as in the setting of each receiver.

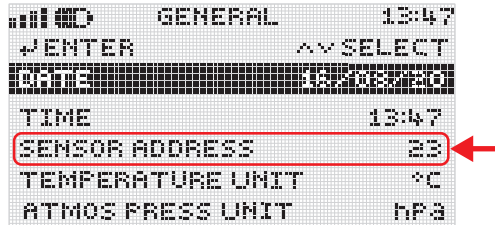

### Change Receiver wireless address:

1. press Settings button go to SETTINGS page
2. press Enter on GENERAL to go to GENERAL setting page
3. press Enter on SENSOR ADDRESS
4. press UP/DOWN cursor to change the number in coordination with the AD number on sensor label
5. When the sensor and receivers are wirelessly connected, the receiver's LED indicator will beep twice and flash GREEN light twice.

*When the wireless connection between sensor and receiver is lost for over 10 minutes, the LED indicator will flash red light every 10 seconds.*

## Time and Measurement Units Setting

### Change date, time, temperature unit, atmosphere pressure units:

1. press Settings button go to SETTINGS page
2. press Enter on GENERAL to go to GENERAL setting page
3. press UP/DOWN and Enter to select and change the section unit

### Change wind speed measurement unit:

1. press Settings button go to SETTINGS page
2. press Enter on WIND SPEED to go to WIND SPEED setting page
3. press Enter on Wind SPEED UNIT
4. press UP/DOWN cursor to select the unit: m/s (default), km/hr, MPH, knots

## ■ Wind Speed Alarm

The built-in buzzer will be triggered when the wind speed exceeds the set threshold. The display backlight flashes AMBER and LED indicator continuously lights up in RED.

### Set alarm threshold:

1. press Settings button go to SETTINGS page
2. press Enter on WIND SPEED to go to WIND SPEED setting page
3. press Enter on ALARM THRESHOLD
4. press UP/DOWN cursor to set the wind speed alarm threshold

### Turn on alarm function:

1. press Settings button go to SETTINGS page
2. press Enter on WINDSPEED to go to WINDSPEED setting page
3. press Enter on ALARM
4. press UP/DOWN cursor to select ON

## ■ Data Logging

### Set logging interval: (default interval: 10 seconds)

1. press Settings button go to SETTINGS page
2. press Right button go to DATALOGGING setting page
3. press Enter on LOGGING INTERVAL (select logging interval: 2 sec, 5 sec, 10 sec, 1min, 5min, 10min, 60 min)

*Logging interval can only be altered while the datalogging function is OFF.*

### Start Logging:

1. go to DATALOGGING setting page (see steps above)
2. press Enter on LOGGING
3. press UP/DOWN cursor to select ON
4. Start datalogging: select YES
5.  will display on screen the top left corner to indicate the data logging function is ON

*When the data logging function is ON, the receiver cannot be turn OFF.*

### Finish Logging:

1. go to LOGGING setting (see steps above)
2. press UP/DOWN cursor to select OFF
3. Stop datalogging: select YES
4. A logged file will be created when the logging status switch from “ON” to “OFF”

There are 2 conditions which will automatically turn the data logging function OFF:

- The battery level of the receiver is under 5%.
- There is no available memory space in the receiver

*For long-term data recording, please supply the receiver power through micro USB cord or make sure the battery power for Receiver is sufficient for the entire logging period.*

## Data Export

1. Download and unzip “WR3PR.zip” file to your PC from Scarlet’s website:  
<https://scarlet-tech.com/wp-content/uploads/2021/02/WR3PR.zip>



2. Connect the receiver to PC via micro USB cable.

Make sure the datalogging feature is turn OFF (see Finish Logging)

A new USB drive will show up on your devices list indicates the receiver is connected to your computer.

3. Double click to open the export software “WR3PR.exe”

4. Select the COM Port of your receiver\* then press “Download” button

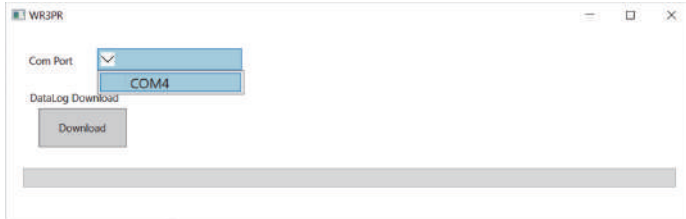

5. Select the download folder for the logged files

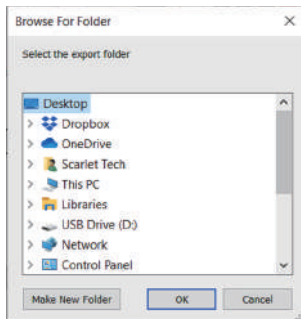

6. Select the export file type

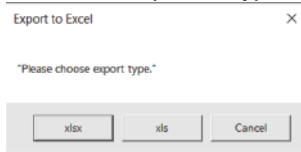

7. WR3PR will start exporting the logged files.

Receiver will display “Data Downloading” during the downloading process.

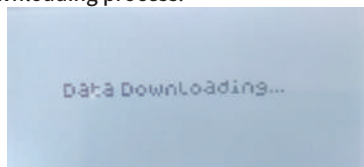
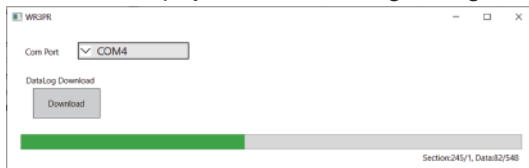



8. Wait for the “Finish” pop-up that indicates the data exporting is complete.

*Depending on the data amount and PC performance, the downloading time will vary from a few minutes up to half an hour.*

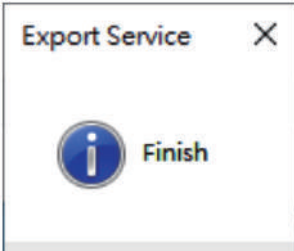

*\*Please update the USB driver if the COM port is unidentified.*

1. Go to “Device Manager”
2. Select the update the “Unknown Device” (or “USB Serial Port”) with exclamation mark.
3. Right-click to update driver

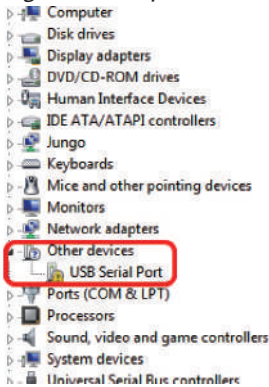

4. Select the driver software “NuvotonCDC” in the Receiver USB drive to update

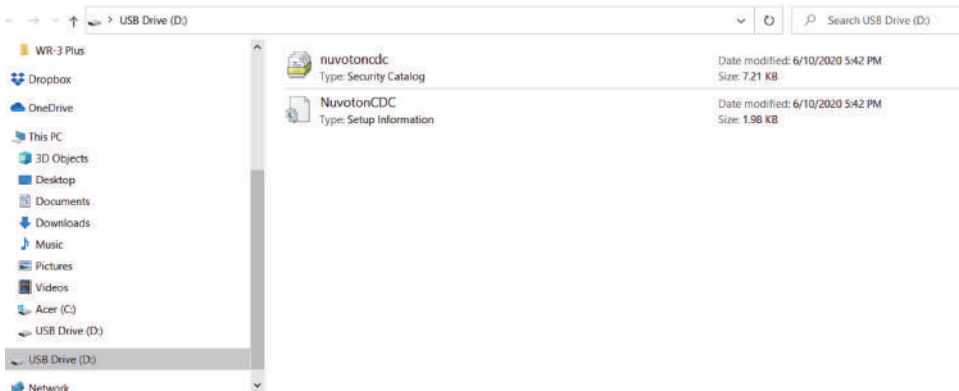

## ■ Power Saving Mode

In power saving mode, the LED indicator will light GREEN every 10 seconds. While the wind speed alarm function is ON, the buzzer will be triggered while wind speed exceeds the set threshold.

### Enable power saving mode:

1. press Settings button go to SETTINGS page
2. press Enter on GENERAL and Down to go to the 2nd page of GENERAL setting
3. press Enter to select DISPLAY AUTO OFF
4. press UP/DOWN cursor to set the idle period: 5min, 10min, 30min

*The receiver display will automatically turn off after the set idle period to save battery power. The display will light up when any key is pressed.*

## ■ Power Off

When the data logging function is ON, the Receiver cannot be powered-off by pressing power button directly. Please make sure to export the data before turn the power off.

### Turn off the DATALOGGING function

1. press Settings button go to SETTINGS page
2. press Enter on LOGGING
3. Turn off datalogging: select YES

### Press Settings go to MAIN menu

Long press the power button for 5 seconds

# Installation

WR-3 Plus's magnetic installation accessories support fast and flexible installation and do not require any welding or wiring on the equipment. The system setup takes place automatically upon booting up.

## ■ Sensor Installation

WR-3 Plus's sensor bottom cap has a 1/4" threaded hole for installation.

You can use Scarlet's **Magnetic Sensor Mounting Bracket** to attach the sensor to any iron/steel surface and to keep it perpendicular to the ground.

1. Loosen the clamp
2. Insert the sensor body from the bottom of the clamp
3. Tighten the clamp
4. Apply wind cups on wind sensor bearing
5. Make sure you hear a "CLICK" sound that indicates all parts are locked in place.
6. Attach the bracket on the desire magnetic surface

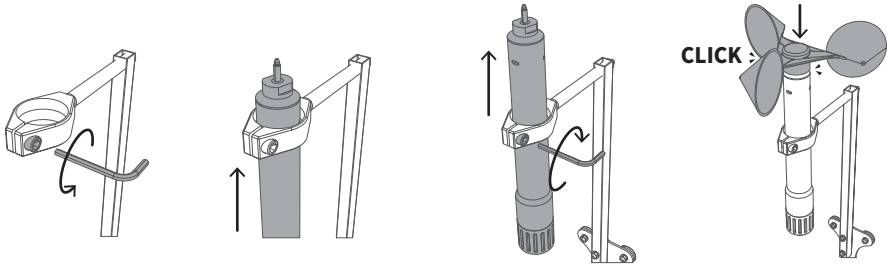

## ■ Receiver Installation

WR-3 Plus's Receiver Holder Kit comes with an anti-slip display holder with neodymium magnets on both ends and three pieces of adhesive metal flakes.

1. Peel off the backing paper of the metal flake to reveal the adhesive side
2. Press and stick the adhesive side of the metal flake to the Receiver's back cover
3. Attach the receiver to the display holder magnetically

You can attach the display holder on any magnetic surface or adhesive the metal flake on the non-magnetic surface first before attaching the magnetic display holder.

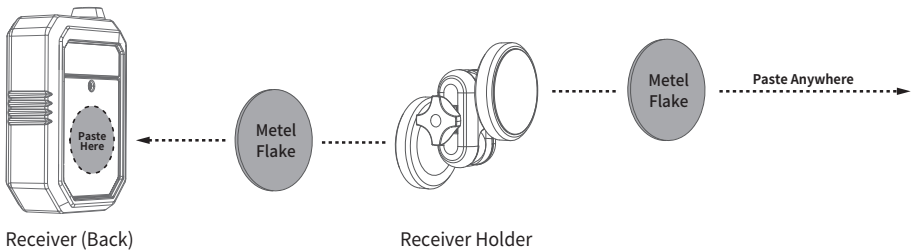

# Technical Specification

---

## Wireless Sensor

Item	Definition
Frequency	868MHz, 915MHz
Distance	Max 500m* (depends on the applied environment)
Data Rate	Every 2 seconds
Power Supply	3.6V 18505 Lithium battery x1
Waterproof Rating	IP67
Weight	360g
Dimension	262.5 x 183.5 x 32mm

## Receiver

Item	Definition
Receiver Buzzer	> 80dB
Built-in Memory	64MB
Output	.xlsx, .xls
Data Logger	Current wind speed Average wind speed Maximum wind speed Current temperature Current atmospheric pressure
Logging Interval	2 seconds, 5 seconds, 10 seconds (default), 1 minute, 5 minutes, 10 minutes, 60 minutes
Power Supply	1.5V AA battery x3
	Micro USB power cord
Dimension	189.6 x 75.6 x 36.3mm
Weight	290g

## Wind Speed Sensor

Item	Definition
Measurement Unit	m/s (default) knots MPH km/hr
Measurement Range	0.3...50 m/s
Measurement Resolution	0.1 m/s 0.1 knots 0.1 MPH 0.1 km/hr
Measurement Accuracy	±2% FS

## Temperature Sensor

Item	Definition
Measurement Unit	°C (default) °F
Measurement Range	-30°C...60°C
Measurement Resolution	0.1°C 0.1°F
Measurement Accuracy	±1°C

## Atmospheric Pressure Sensor

Item	Definition
Measurement Unit	hPa (default) mmHg bar
Measurement Range	500...1100 hPa
Measurement Resolution	1 hPa 0.1 mmHg 0.001 bar
Measurement Accuracy	±4 hPa

# Package Content

---

- Wireless Sensor
- Wind Cups
- Receiver
- Receiver Antenna
- Receiver Holder
- Adhesive Metal Flakes x 3 (for Receiver Holder installation)
- AA Battery x 3 (for Receiver)
- 3.6V 18505 Lithium battery x1 (placed in Sensor)
- User Manual & Certificate



Wireless  
Sensor



Wind Cups



Receiver



Receiver  
Antenna



Receiver  
Holder



AA Battery x 3  
(for Receiver)



3.6V 18505  
Lithium battery x1  
(placed in Sensor)

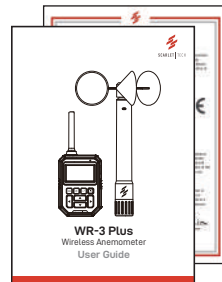

User Manual & Certificate

## Optional Accessories

- Magnetic Sensor Mounting Bracket
- Spare Wind Cups
- Spare Sensor Battery (3.6V 18505 Lithium battery)
- External Antenna



Magnetic Sensor  
Mounting Bracket



Wind Cups



3.6V 18505 Lithium battery x1  
(placed in Sensor)

# Safety, Maintenance, & Warranty

## Operating Environment

The operating temperature of the anemometer system is designed to work in an ambient temperature between 5°C to 60°C (40°F to 140°F) at 20~80%RH. The storage temperature is between -20°C to 60°C (-4°F to 140°F). The instrument can be damaged if stored and operated outside of these temperature ranges. Avoid exposing the instrument to extreme changes of weather and or temperature in a continuous short period of time.

## Sensor Battery Replacement

The wireless sensor is powered by a 3.6V 18505 Lithium battery. Its battery level is displayed on the 2nd page of the GENERAL setting.

- Turn the battery cap counter clockwise to remove it.
- Take out the battery container from the sensor.
- Replace the battery with a new 3.6V 18505 Lithium battery.

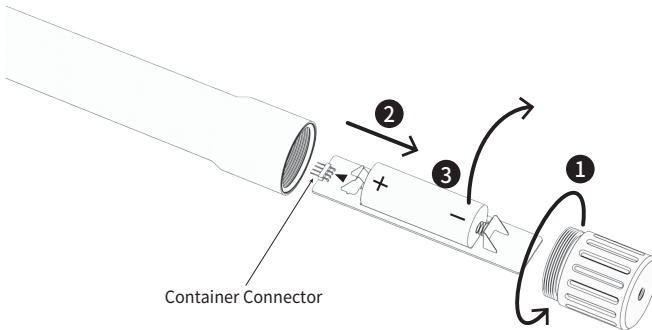

- Put back the battery container into the sensor (Please note the placement direction).

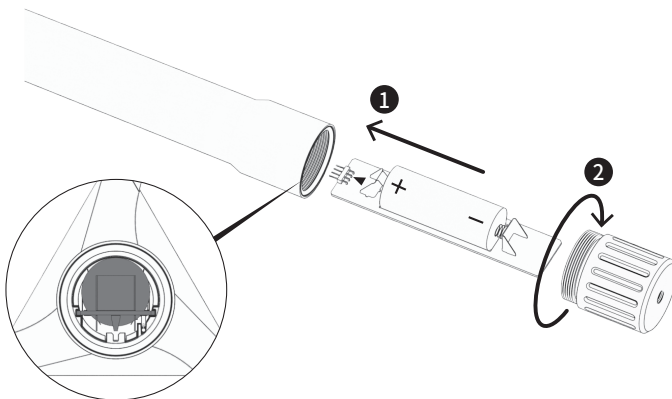



- Make sure the O-ring is correctly aligned to the battery cap for waterproof protection.
- Put back the battery cap in clockwise direction to finish the battery changing.



## Receiver Battery Replacement

The receiver is powered by 3 AA 1.5V batteries. The battery level is displayed on the top of the display.

- Remove the screw and then remove the battery cover on the back.
- Replace the batteries with 3 new 1.5V AA batteries.
- Place back the battery cover and fasten the screw.



## Warranty Conditions

This instrument is guaranteed for a one-year limited warranty against material or production defects, in accordance with our general sales conditions. During the warranty period, Scarlet Tech reserves the right to decide either to repair or replace the product.

Should you need any reason to return the instrument for repair or replacement, take prior agreements with the local distributor from whom you bought it. Please use the original packaging for return. Do not forget to enclose a report describing the reasons for returning (detected fault). Any damage that occurred in transit due to non-original packaging will be charged to the customer.

Scarlet Tech's One-year Limited Warranty does NOT apply to:

- Accessories and batteries (not covered by warranty)
- Repairs made necessary by improper use or improper combination with incompatible accessories or equipment.
- Repairs made necessary by improper shipping material causing damages in transit.
- Repairs made necessary by previous attempts for the repair carried out by non-skilled or unauthorized personnel.
- Instruments for whatever reason modified by the customer himself without the explicit authorization of our Technical Dept.

The contents of this manual may not be reproduced in any form whatsoever without the authorization from Scarlet Tech.